



文陽企業有限公司

WEN YANG ENTERPRISE CO., LTD

IP55 進口落地型組合箱 / 不鏽鋼 / 金屬電控箱 / PLC
歐規落地型組合箱 / 變頻器控制箱 / ABS 控制盒



IP55歐規組合箱•IP66 AE系列電控箱•特殊電控箱專業製造

Wall Mounting Watertight Metal Enclosures



SC97082 / SC97083



CERT NO. 403479 台灣總代理



Waterproof & Dustproof

防水&防塵 最堅實的保護



單門組合箱



雙門組合箱



19"電腦機櫃



不鏽鋼組合箱

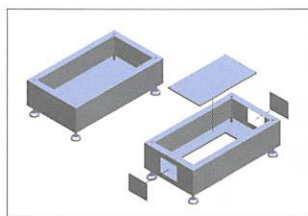

■不鏽鋼底座



■強力磁吸式LED日光燈，可任意移動、強力附著、節省安裝、固定時間人力，照亮您想亮的地方。
(專利產品M324165)

組合式骨架



■箱體前後保護桿設計，以利拖板車任意移動、載重不變形。



■KD拆卸式框架，組裝迅速、結構超強，節省運輸成本、空間。



堅強陣容 23年業界經驗、不斷創新與研發
 備受各界肯定與支持



完美品質 一貫化作業流程，品管與交期兼顧



德國KUKA 焊接機械手臂



德國TRUMPF Trubend 3120 CNC油壓折床。



出廠前，各項組裝檢驗、品保、確認後出貨。



日本AMADA VIPROS 357 QUEEN 油壓沖床。



義大利GECAM 自動磨毛邊機。



荷蘭SAFAN 傳動式快速折床。



德國原料SONDERHOFF二合一PU發泡成型機。此為灌注於門板上，與箱體緊密共存，其耐溫-40°C~100°C之常溫。正常使用年限為10~20年，不起塵、不變質、不脫落，永保氣密度。



■ 強力磁吸式LED日光燈
(專利產品M324165)

可任意移動、強力附著、節省安裝、固定時間人力，照亮您想亮的地方。



■ 雙門上下特殊防水密合設計、並通過IP55測試

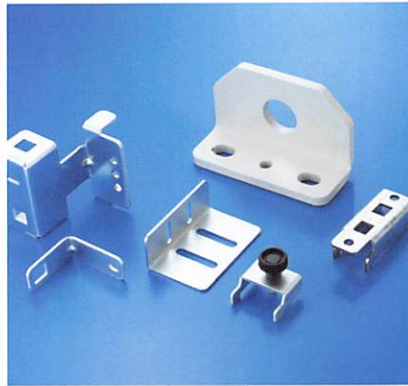

■ 自行開發、設計之零配件



■ 底板滑組

可使完裝後之底板，上箱定位。往後滑動到後端停止時，再往上推行至定點，即可固定螺絲。



■ 防水PU發泡、一體成型灌注

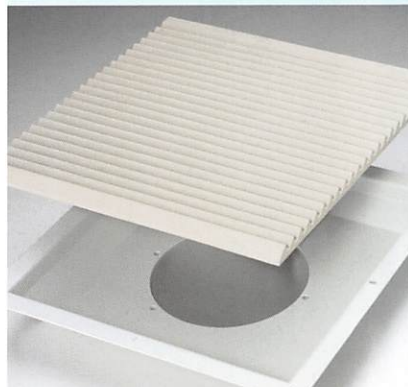

■ 過濾網組集風罩

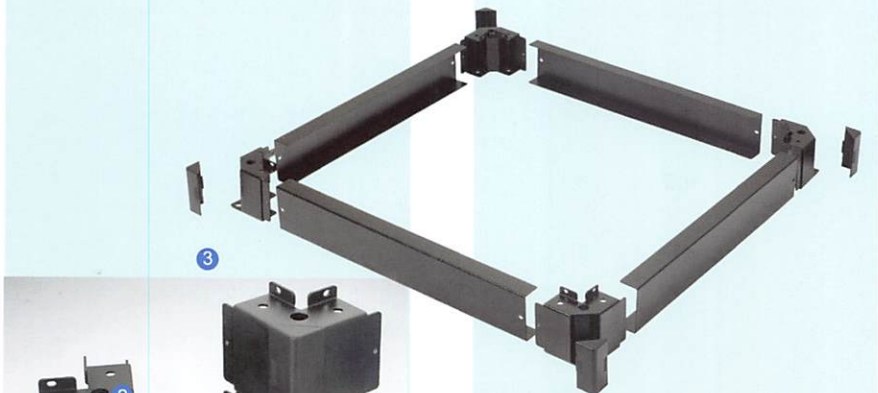

■ 拆卸式底座

1. 每個獨立腳座可承受1800kg以上，絕不變形。
2. 獨立腳座皆有調整高低，並於外側固定地上之功能。
3. 高度以100mm高為增減。
4. 塑製護蓋，美觀大方。



■ 連結旋轉固定座 RC43 / RC64



■ 可任意裝配之孔排管

歐規落地型組合箱尺寸圖

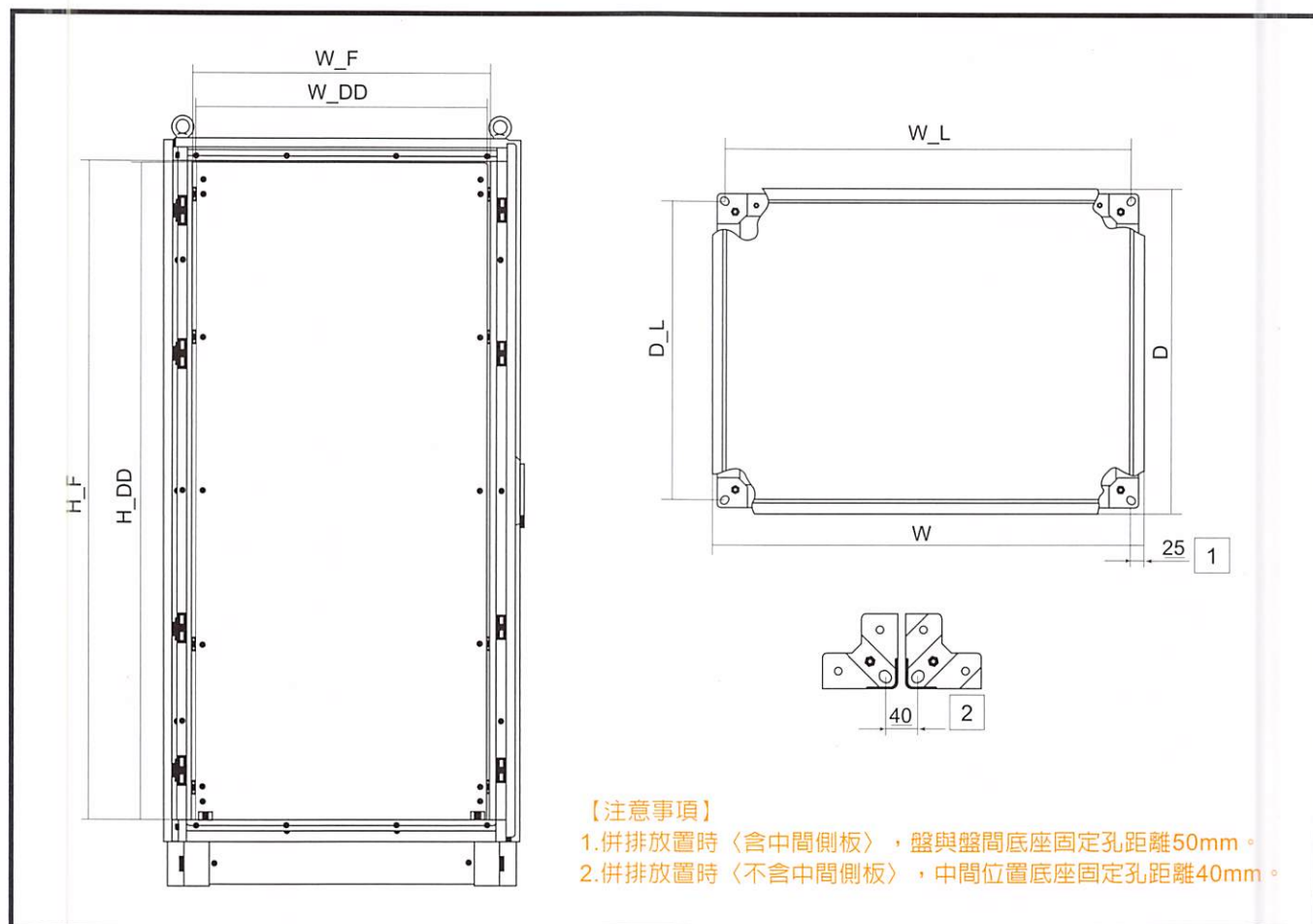

【注意事項】

1. 併排放置時〈含中間側板〉，盤與盤間底座固定孔距離50mm。
2. 併排放置時〈不含中間側板〉，中間位置底座固定孔距離40mm。

底板規格表

規格	框內寬度 W_F(mm)	底板寬度 W_DD(mm)
500	378	360
600	478	460
700	578	560
800	678	660
1000	878	860
1200	1078	1060
1300	1178	1160
1400	1278	1260
1500	1378	1360

規格	框內高度 W_F(mm)	底板高度 W_DD(mm)
1600	1502	1495
1800	1702	1695
2000	1902	1895
2100	2002	1995

底座施工中心距

箱體深度		
規格	D (mm)	D_L (mm)
500	512	463
600	612	563
700	712	663
800	812	763

箱體寬度		
規格	W (mm)	W_L (mm)
500	512	463
600	612	563
700	712	663
800	812	763
1000	1012	963
1200	1212	1163
1300	1312	1263
1400	1412	1363
1500	1512	1463

歐規落地型組合箱尺寸圖

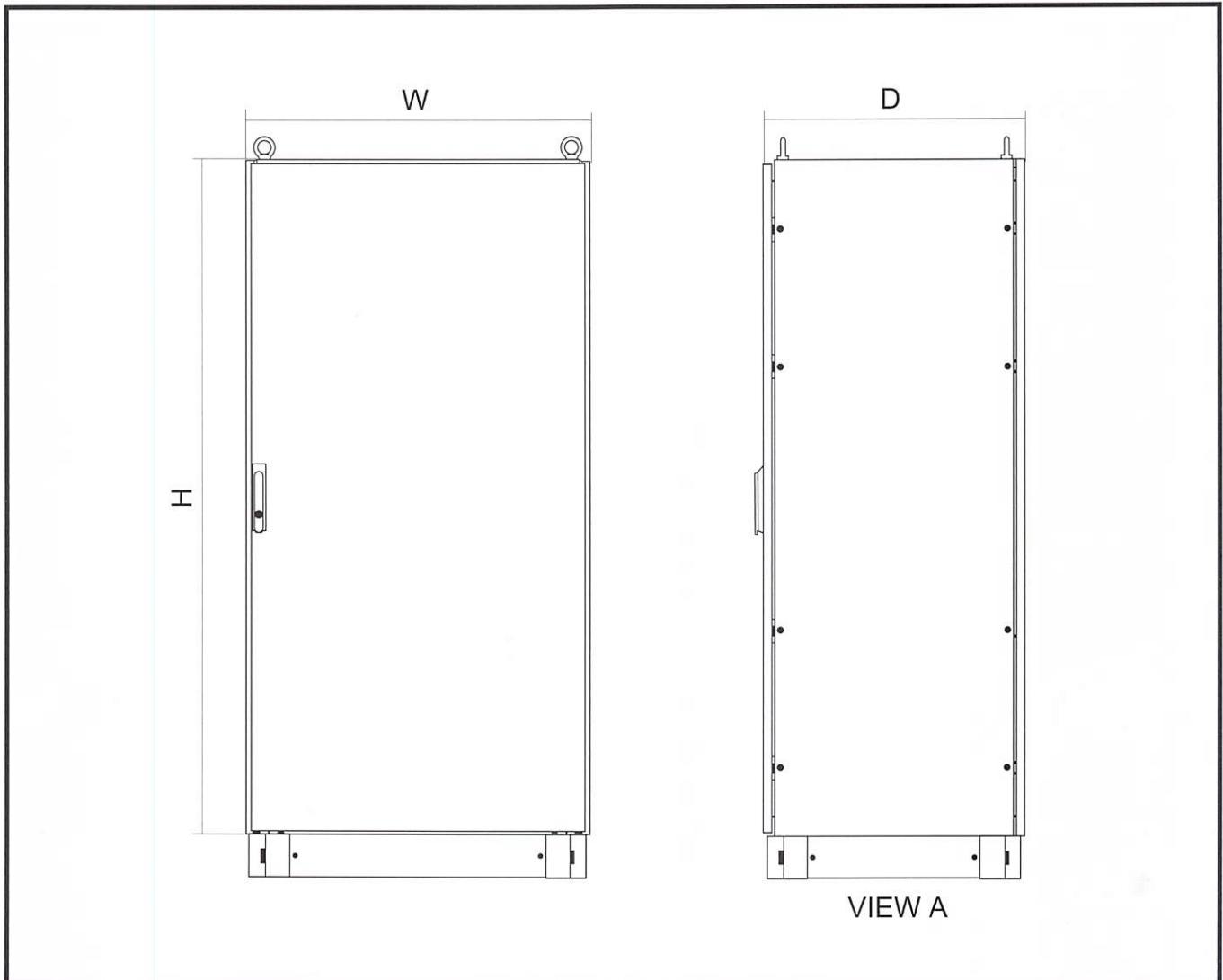

歐規組合箱規格表

H	W (單門)	W (雙門)	D
1600	500	1000	500
1800	600	1200	600
2000	700	1300	700
2100	800	1400	800
	1000	1500	

以上規格不含底座

CVS進口控制箱



CERT NO. 403479 台灣總代理



NO.	型號	尺寸 (HxWxD)	掛鉤	型式
1	CR252010	250 x 200 x 100	0	直
2	CR252015	250 x 200 x 150	0	直
3	CR302515	300 x 250 x 150	4	直、橫
4	CR302520	300 x 250 x 200	4	直、橫
5	CR303015	300 x 300 x 150	4	直
6	CR303020	300 x 300 x 200	4	直
7	CR403015	400 x 300 x 150	4	直、橫
8	CR403020	400 x 300 x 200	4	直、橫
9	CR404020	400 x 400 x 200	4	直
10	CR504015	500 x 400 x 150	4	直、橫
11	CR504020	500 x 400 x 200	4	直、橫
12	CR504025	500 x 400 x 250	4	直、橫
13	CR505020	500 x 500 x 200	4	直
14	CR505025	500 x 500 x 250	4	直
15	CR604015	600 x 400 x 150	4	直、橫
16	CR604020	600 x 400 x 200	4	直、橫
17	CR605020	600 x 500 x 200	4	直、橫
18	CR605025	600 x 500 x 250	4	直、橫
19	CR606020	600 x 600 x 200	4	直
20	CR606025	600 x 600 x 250	4	直
21	CR606030	600 x 600 x 300	4	直
22	CR705020	700 x 500 x 200	4	直、橫
23	CR705025	700 x 500 x 250	4	直、橫
24	CR806020	800 x 600 x 200	4	直
25	CR806025	800 x 600 x 250	4	直
26	CR808025	800 x 800 x 250	4	直
27	CR1006030	1000 x 600 x 300	4	直
28	CR1008030	1000 x 800 x 300	4	直
29	CR1208030	1200 x 800 x 300	4	直

備註：

1.歐美品質、符合IEC529測試、防塵防水、高級粉體烤漆。

2.庫存尺寸齊全、交貨迅速。

3.以上價格含底板、掛鉤，不含稅。

4.提供面板沖孔服務，酌收工資。

IP55 掛壁式底板孔及尺寸圖

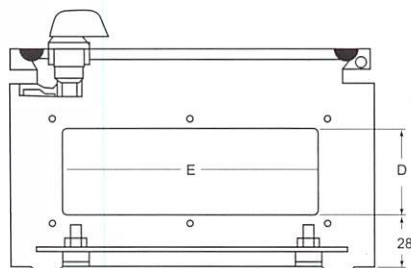
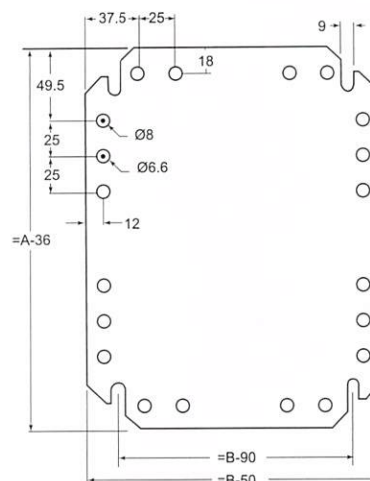
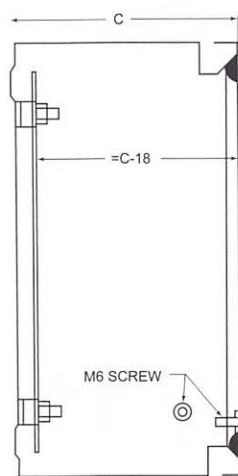
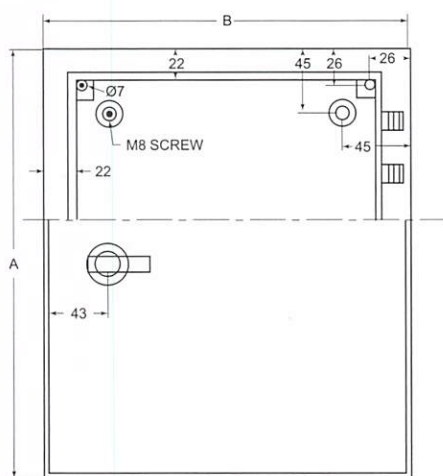

PART NAME	MATERIAL	FINISH
BODY	1.4 MM M.S	RAL7032 (EPOXY POWDER COATED)
COVER	1.4 / 2.0 MM M.S	RAL7032 (EPOXY POWDER COATED)
MOUNTING PLATE	1.4 / 2.0 MM M.S	RAINBOW ZINC PLATED
GLAND PLATE	1.4 MM M.S	RAL7032 (EPOXY POWDER COATED)
WALL BRACKET	2.0 / 3.0 MM M.S	RAINBOW ZINC PLATED

MODEL	A	B	C	D	E	GLAND OPENINGS	NO. OF LOCKS	NO. OF WALL BRACKETS	WEIGHT KG
CR302515	300	250	153	60	174	1	1	4	5.4
CR302520	300	250	203	60	174	1	1	4	6.0
CR303015	300	300	153	60	174	1	1	4	6.0
CR303020	300	300	203	60	174	1	1	4	6.8
CR403015	400	300	153	60	174	1	1	4	8.0
CR403020	400	300	203	60	174	1	1	4	8.4
CR404020	400	400	203	88	259	1	1	4	10.6
CR504015	500	400	153	60	174	1	1	4	11.8
CR504020	500	400	203	88	259	1	1	4	13.0
CR504025	500	400	253	88	259	1	1	4	14.0
CR505020	500	500	203	88	259	1	1	4	15.2
CR505025	500	500	253	115	310	1	1	4	16.6
CR604015	600	400	153	60	174	2	2	4	14.2
CR604020	600	400	203	88	259	2	2	4	15.2
CR605020	600	500	203	88	259	2	2	4	19.7
CR605025	600	500	253	115	310	2	2	4	21.0
CR606020	600	600	203	115	310	2	2	4	23.0
CR606025	600	600	253	115	310	2	2	4	24.6
CR705020	700	500	203	88	259	2	2	4	22.0
CR705025	700	500	253	115	310	2	2	4	23.6
CR806020	800	600	203	115	310	2	2	4	29.0
CR806025	800	600	253	115	310	2	2	4	30.6
CR808025	800	800	253	115	310	4	2	4	39.5
CR1006030	1000	600	303	115	310	2	2	4	39.0
CR1008030	1000	800	303	115	310	4	2	4	50.0
CR1208030	1200	800	303	115	310	4	2	4	58.5

CVS歐式門板、泡綿



CERT NO. 403479 台灣總代理

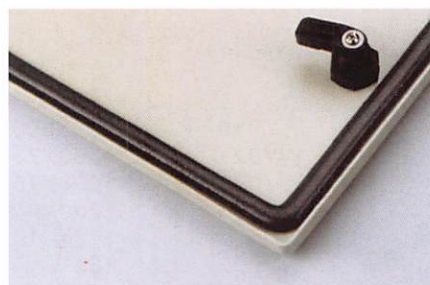

■ 活動出線板、掛壁配件

■ 歐式一體成型泡綿及門板

自製便箱



NO.	型號	尺寸 (HxWxD)	型式	備註
1	WY001	250 x 250 x 160		
2	WY002	300 x 200 x 160	直、橫	
3	WY003	300 x 250 x 160	直、橫	
4	WY004	300 x 300 x 160		
5	WY005	350 x 300 x 160	直、橫	
6	WY006	400 x 300 x 160	直、橫	
7	WY007	400 x 350 x 160	直、橫	
8	WY008	400 x 400 x 180		
9	WY009	450 x 350 x 180	直、橫	
10	WY010	450 x 400 x 180	直、橫	
11	WY011	500 x 400 x 200	直、橫	平把手
12	WY012	500 x 500 x 200		平把手
13	WY013	600 x 400 x 200	直、橫	平把手
14	WY014	600 x 500 x 200	直、橫	平把手
15	WY015	700 x 500 x 200	直、橫	平把手
16	WY016	700 x 600 x 200	直、橫	平把手
17	WY017	800 x 550 x 200	直、橫	平把手
18	WY018	800 x 600 x 250	直、橫	平把手
19	WY019	900 x 600 x 200	直	平把手
20	WY020	900 x 600 x 250	直	平把手
21	WY021	1000 x 750 x 200	直	平把手
22	WY022	1000 x 750 x 280	直	平把手
23	WY023	1200 x 800 x 300	直	平把手
24	WY024	270 x 210 x 120	橫	MC盒
25	WY025	190 x 180 x 120	橫	MC盒

備註：

1. 本公司便箱產品採粉體烤漆。
2. 面板任何沖孔方便不損表面。
3. 庫存任何尺寸、交貨迅速確實。

VI06-3 集風罩濾網組+冷卻扇

FilterFan Packages for 3" (80x80x25mm) Fan

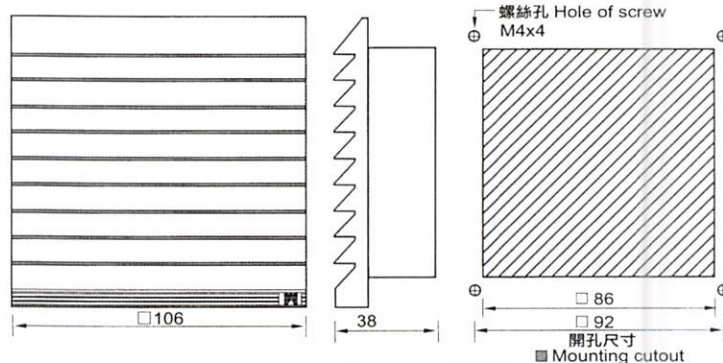
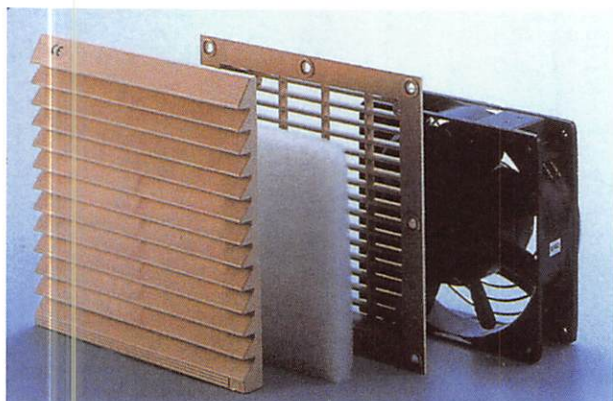

VI20-3.5 通風過濾網組+冷卻扇

FilterFan Packages for 3.5" (92x92x25mm) Fan

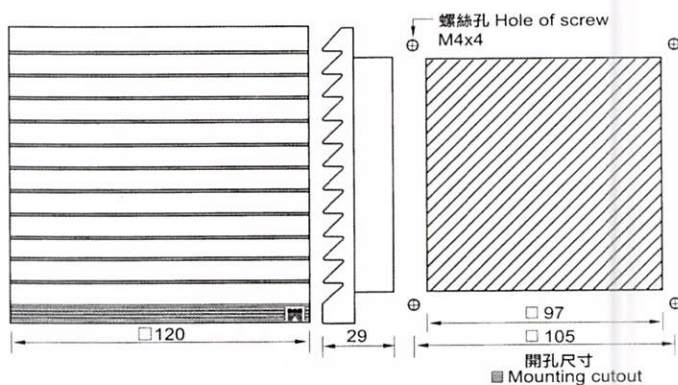
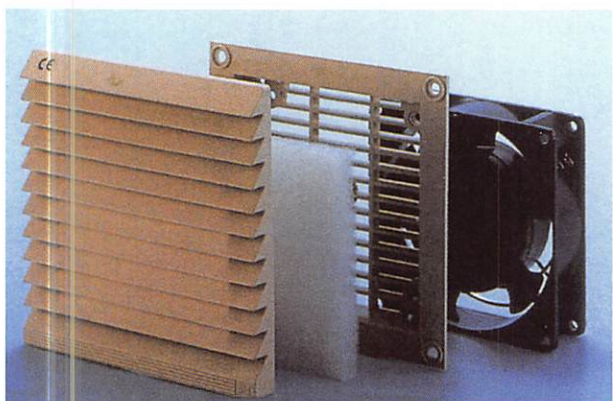

VI57-4 通風過濾網組+冷卻扇

FilterFan Packages for 4" (120x120x38mm) Fan

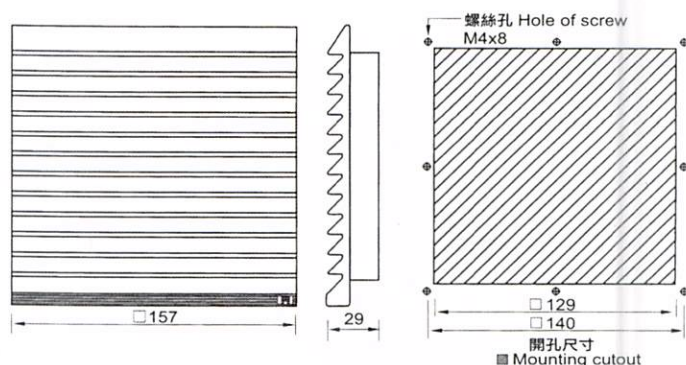
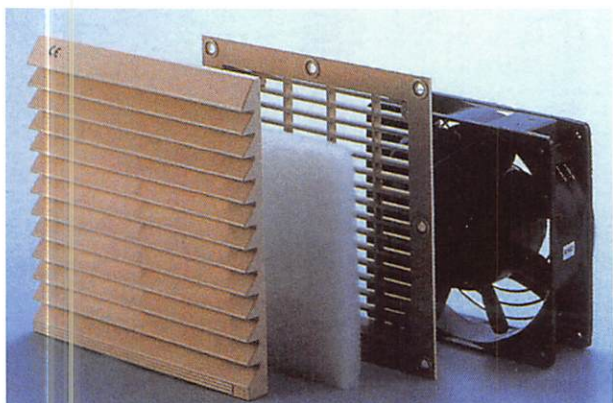

V208-6 通風過濾網組+冷卻扇

FilterFan Packages for 6" (172x150x51mm) Fan

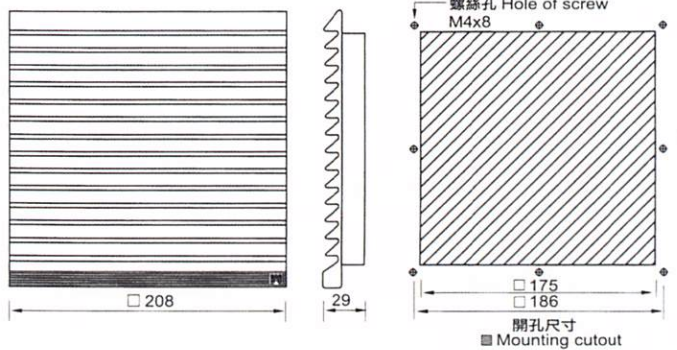
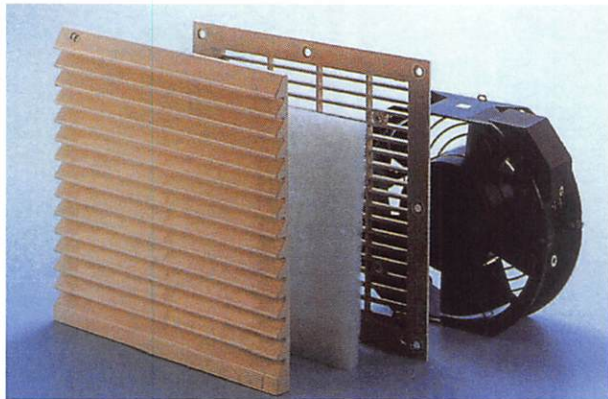

EVI25-4 筒式過濾網

FilterFan Packages for 4" (120x120mm) Fan

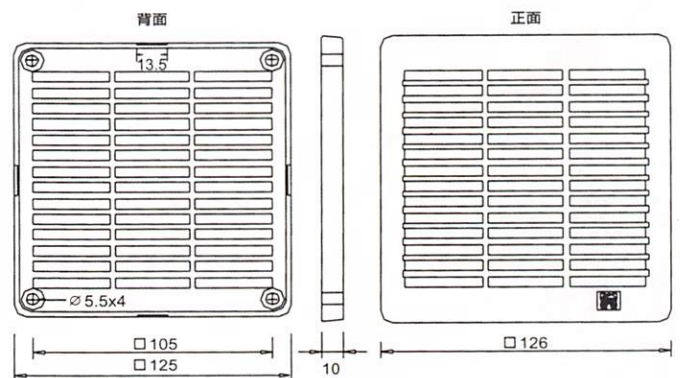

TV220

Exhaust Radial Fans, Roof-mounted
For Ø220mm Centrifugal Fans

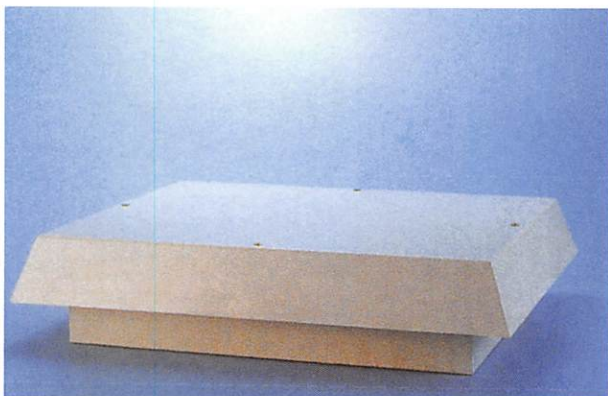

天井式散熱裝置

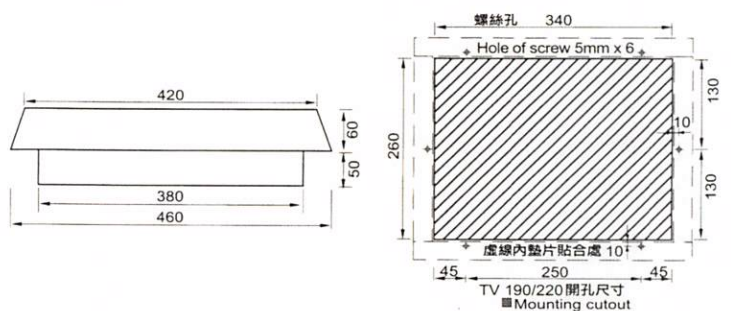

ABS 控制盒

● IP68 ●

品質第一、台灣製造

產品特色

- 外型高雅美觀
- 箱體耐蝕防鏽
- 絕緣安全性高
- 重量輕不破裂

系列產品



▲ 300-400



▲ 230-300



▲ 160-230



▲ 100-190



▲ 100-190H



▲ 1522B



▲ DS-PG-10P



▲ DS-PG-15P

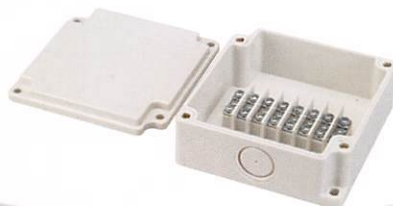

▲ DS-PG-8P

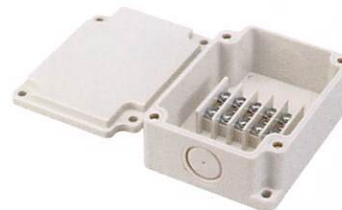

▲ DS-PG-5P

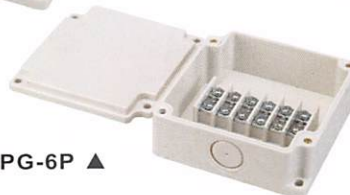

DS-PG-6P ▲



DS-PG-4P ▲

JL 控制盒產品規格

產品編號	內徑	外徑	材質	包裝	備註
300-400	280W x 380L x 160D	300W x 400L x 180H	ABS	5個/箱	活動式底板
230-300	210W x 280L x 160D	230W x 300L x 180H	ABS	10個/箱	活動式底板
160-230	145W x 215L x 87D	160W x 230L x 100H	ABS	10個/箱	活動式底板
160-230H	145W x 215L x 123D	160W x 230L x 140H	ABS	10個/箱	活動式底板
100-190	85W x 175L x 70D	100W x 190L x 85H	ABS	30個/箱	固定式底板
100-190H	85W x 175L x 110D	100W x 190L x 125H	ABS	20個/箱	固定式底板
1522B		150W x 220L x 100H	ABS	20個/箱	活動式底板
DS-PG-10P		75W x 110L x 40H	ABS	100個/箱	防水接線盒
DS-PG-15P		40W x 96L x 160H	ABS	100個/箱	防水接線盒
DS-PG-8P		40W x 96L x 96H	ABS	100個/箱	防水接線盒
DS-PG-6P		40W x 96L x 96H	ABS	100個/箱	防水接線盒
DS-PG-5P		40W x 96L x 73H	ABS	100個/箱	防水接線盒
DS-PG-4P		40W x 96L x 73H	ABS	100個/箱	防水接線盒

ABS 控制盒

● IP68 ●

品質第一、台灣製造

產品特色

- 外型高雅美觀
- 箱體耐蝕防鏽
- 絕緣安全性高
- 重量輕不破裂

系列產品



▲ JL-00A



▲ JL-00B



▲ JL-00B(C)



▲ JL-00C



▲ JL-00C(C)



▲ JL-002(C)



▲ JL-003(C)

JL控制盒產品規格

產品編號	內徑	外徑	材質	包裝	備註
JL-00A	90W x 130L x 86D	120W x 150L x 103H	ABS 樹脂	20個/箱	
JL-00B	101W x 160L x 100D	145W x 180L x 118H	ABS 樹脂	20個/箱	
JL-00B(C)	101W x 160L x 100D	145W x 180L x 118H	ABS 樹脂	20個/箱	
JL-00C	145W x 215L x 108D	180W x 235L x 125H	ABS 樹脂	10個/箱	
JL-00C(C)	145W x 215L x 108D	180W x 235L x 125H	ABS 樹脂	10個/箱	
JL-002	178W x 228L x 141D	210W x 250L x 160H	ABS 樹脂	10個/箱	
JL-002(C)	178W x 228L x 141D	210W x 250L x 160H	ABS 樹脂	10個/箱	
JL-003	228W x 278L x 150D	264W x 300L x 181H	ABS 樹脂	10個/箱	
JL-003(C)	228W x 278L x 150D	264W x 300L x 181H	ABS 樹脂	10個/箱	
JL-BH		95W x 150L x 103H			開發中

★產品編號 A. B. C. 為固定底板

★產品編號 2. 3. 為活動式底板

★產品編號 (C) 為透明上蓋

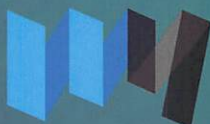
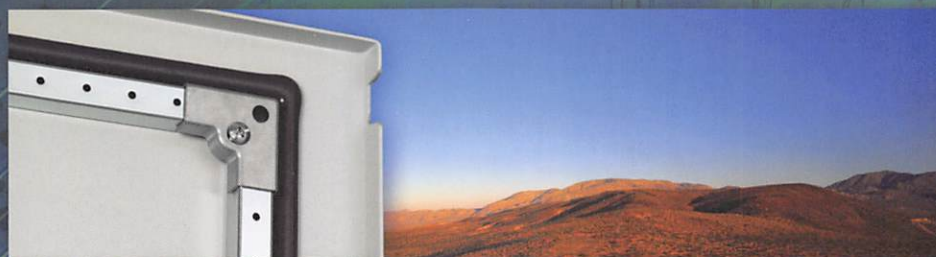

文陽企業有限公司
WEN YANG ENTERPRISE CO., LTD

台中市烏日區太明路成豐巷290號
No.290 Lane Chen-Fong, Tai-ming Rd.,
Wurih Dist, Taichung City 414, Taiwan
TEL: 886-4-23352885(REP.) FAX: 886-4-23352849

www.wen-yang.com.tw